

## LP Gas Outdoor Fireplace

Model No. GAD860SP

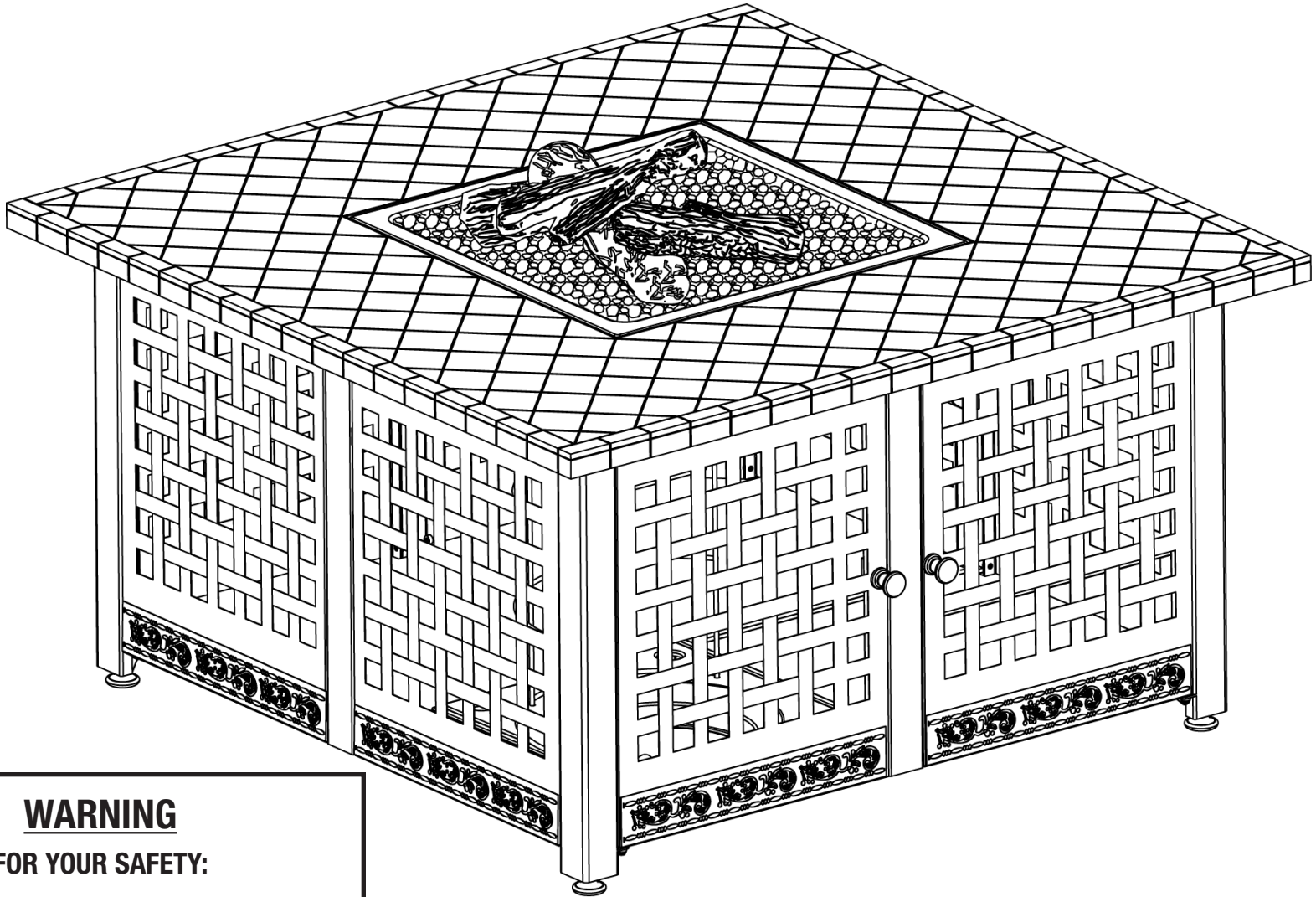

**WARNING**  
FOR YOUR SAFETY:

For Outdoor Use Only (outside any enclosure)  
Do Not Use For Cooking.

**WARNING**  
FOR YOUR SAFETY:

- ▲ If the information in this manual is not followed exactly, a fire or explosion may result causing property damage, personal injury or loss of life.
- ▲ Do not store or use gasoline or other flammable vapors and liquids in the vicinity of this or any other appliance.
- ▲ **WHAT TO DO IF YOU SMELL GAS:**
  - Do not try lighting any appliance.
  - Do not touch any electrical switch; do not use any phone in your building.
  - Immediately call your gas supplier from a neighbor's phone.
  - Follow the gas supplier's instructions.
  - If you cannot reach your gas supplier, call the fire department.
- ▲ Installation and service must be performed by a qualified installer, service agency or gas supplier.
- ▲ Improper installation, adjustment, alteration, service or maintenance can cause injury or property damage.
- ▲ Read the installation, operation, and maintenance instructions thoroughly before installing or servicing this equipment.
- ▲ Save these instructions for future reference. If you are assembling this unit for someone else, give this manual to him or her to read and save for future reference.

### Table of Contents

Dangers and Warnings . . . . .	Page 2
Exploded View & Hardware . . . . .	3
Assembly Instructions . . . . .	4
Installing LP Gas Tank . . . . .	7
Insert LP Gas Tank . . . . .	7
Secure LP Gas Tank . . . . .	7
Connect LP Gas Tank . . . . .	7
Disconnect LP Gas Tank . . . . .	7
Operating Instructions . . . . .	8
Checking for Leaks . . . . .	8
Lighting . . . . .	8
Turning Off . . . . .	8
Cleaning and Care . . . . .	8
Inspecting . . . . .	8
Cleaning . . . . .	8
Storing . . . . .	8
Product Registration . . . . .	9
Limited Warranty . . . . .	9
Troubleshooting . . . . .	9

The use and installation of this product must conform to local codes. In absence of local codes, use the latest edition of the *National Fuel Gas Code, ANSI Z223.1/NFPA 54, CAN/CGA-B149.1, Natural Gas and Propane Installation Code.*

For installation in Canada - these instructions, while generally acceptable do not necessarily comply with the Canadian installation codes, particularly with piping above and below ground. In Canada the installation of this appliance must comply with local codes and/or standard CAN/CGA B149.1 (installation code for propane burning appliances and equipment).

California Proposition 65: Chemicals known to the State of California to cause cancer, birth defects, or other reproductive harm are created by the combustion of propane.

Manufactured in China for:  
Blue Rhino Global Sourcing, Inc  
Winston-Salem, NC 27105 USA  
1.800.762.1142, www.bluerhino.com

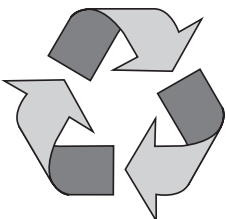

Made from 70% Bagasse

(Environmentally Friendly Sugar Cane Pulp By-product)



**DANGERS and WARNINGS: FOR YOUR SAFETY**

**▲ DANGER:** Failure to follow the dangers, warning and cautions in this manual may result in serious bodily injury or death, or in a fire or an explosion causing damage to property.

**▲ WARNING:**

- ▲ This appliance is for outdoor use only, and shall NOT be used in a building, garage, or any other enclosed area.
- ▲ Do NOT operate, light or use this appliance within 8 feet of walls, structures or buildings.
- ▲ Do NOT use this outdoor fireplace for indoor heating. TOXIC carbon monoxide fumes can accumulate and cause asphyxiation.
- ▲ This outdoor fireplace is NOT for commercial use.
- ▲ This outdoor fireplace is for use with liquid propane (LP) gas only. The conversion to or attempted use of natural gas in this outdoor fireplace is dangerous and will void your warranty.
- ▲ LP gas Characteristics:
  - a. LP gas is flammable and hazardous if handled improperly. Become aware of the characteristics before using any LP gas product.
  - b. LP gas is explosive under pressure, heavier than air, and settles and pools in low areas.
  - c. LP gas in its natural state has no odor. For your safety, an odorant is added that smells like rotten cabbage.
  - d. Contact with LP gas can cause freeze burns to skin.
- ▲ LP gas tank needed to operate. Only tanks marked “propane” may be used.
  - a. The LP gas supply tank must be constructed and marked in accordance with the *Specifications for LP gas LP gas tanks of the U.S. Department of Transportation (DOT) or the National Standard of Canada, CAN/CSA-B339, LP gas tanks, Spheres and Tubes for the Transportation of Dangerous Goods; and Commission.*
  - b. LP gas tank must be arranged for vapor withdrawal.
  - c. The LP gas tank must have a listed overfilling prevention device (OPD) and a QCCI or Type I (CGA810) LP gas tank connection.
  - d. The LP gas tank must have a tank collar to protect the tank valve.
  - e. Never use an LP gas tank with a damaged body, valve, collar, or footing.
  - f. Dented or rusted LP gas tanks may be hazardous and should be checked by your LP gas supplier prior to use.
  - g. The LP gas tank should not be dropped or handled roughly.
  - h. Tanks must be stored outdoors out of the reach of children and must not be stored in a building, garage, or any other enclosed area. Your LP gas tank must never be stored where temperatures can reach over 125°F.
  - i. Never keep a filled LP gas tank in a hot car or car trunk. Heat will cause the gas pressure to increase, which may open the relief valve and allow gas to escape.
  - j. Place dust cap on valve outlet whenever the LP gas tank is not in use. Only install the type of dust cap on the LP gas tank valve outlet that is provided with the LP gas tank valve. Other types of caps or plugs may result in leakage of propane.
  - k. Do not store a spare LP gas tank under or near this appliance.
  - l. Never fill the tank beyond 80 percent full.
- ▲ Your outdoor fireplace has been checked at all factory connections for leaks. Recheck all connections, as movement in shipping can loosen connections.
- ▲ Check for leaks even if your unit was assembled for you by someone else.
- ▲ Do not operate if gas leak is present. Gas leaks may cause a fire or explosion.
- ▲ You must follow all leak-checking procedures before operating. To prevent fire or explosion hazard when testing for a leak:
  - a. Always perform leak test before lighting the outdoor fireplace and each time the tank is connected for use.
  - b. No smoking. Do not use or permit sources of ignition in the area while conducting a leak test.
  - c. Conduct the leak test outdoors in a well-ventilated area.
  - d. Do not use matches, lighters, or a flame to check for leaks.
  - e. Do not use outdoor fireplace until any and all leaks are corrected. If you are unable to stop a leak, disconnect the LP gas supply. Call a gas appliance serviceman or your local LP gas supplier.
- ▲ Do not store or use gasoline or other flammable liquids or vapors within 25 feet (7.62 m) of this appliance.
- ▲ Do not use in an explosive atmosphere. Keep outdoor fireplace area clear and free from combustible materials, gasoline and other flammable vapors and liquids.
- ▲ This outdoor fireplace is NOT to be operated by children.
- ▲ This outdoor fireplace is NOT to be used in or on boats or recreational vehicles.
- ▲ Always use in accordance with all applicable local, state and national codes. Contact your local fire department for details on outdoor burning.
- ▲ When using this outdoor fireplace, exercise the same precautions you would with any open fire.
  - ▲ The use of alcohol, prescription or non-prescription drugs may impair the consumer's ability to properly assemble or safely operate this outdoor fireplace.
  - ▲ Do NOT use this outdoor fireplace without reading the entire “Owner's Manual”.
  - ▲ Do NOT burn solid fuels such as: wood, charcoal briquets, lump charcoal, manufactured logs, driftwood, trash, leaves, paper, cardboard, plywood, painted or stained or pressure treated wood in this outdoor fireplace.
  - ▲ It is essential to keep the outdoor fireplace's valve compartment, burners, and circulating air passages clean. Inspect outdoor fireplace before each use.
  - ▲ Do NOT alter this outdoor fireplace in any manner.
  - ▲ Do NOT use this outdoor fireplace until it is COMPLETELY assembled and all parts are securely fastened and tightened.
  - ▲ Do NOT store another LP gas tank within 10 feet (3.05 m) of this outdoor fireplace while it is in operation.
  - ▲ Do NOT use this outdoor fireplace near automobiles, trucks, vans or recreational vehicles.
  - ▲ Do NOT use this outdoor fireplace under any overhead or near any unprotected combustible constructions. Avoid using near or under overhanging trees and shrubs.
  - ▲ Always use this outdoor fireplace on a hard, level non-combustible surface such as concrete, rock or stone. An asphalt or blacktop surface may not be acceptable for this purpose.
  - ▲ Do NOT use this outdoor fireplace for cooking.
  - ▲ Do NOT use this outdoor fireplace if any part has been under water. Immediately call a qualified service technician to inspect the appliance and to replace any part or control system and any gas control which has been under water.
  - ▲ Do NOT wear flammable or loose clothing when operating this outdoor fireplace.
  - ▲ Do NOT use in windy conditions.
  - ▲ Do NOT use this outdoor fireplace unless burner and log set are securely in place.
  - ▲ Keep all electrical cords away from a hot outdoor fireplace.
  - ▲ Certain areas of this outdoor fireplace when in use will become too hot to touch. To avoid burns, do not touch hot surfaces until the unit has cooled unless you are wearing protective gear (insulated pot holder or heat resistant gloves or mittens).
  - ▲ Do NOT leave a lit outdoor fireplace unattended, especially around children and pets.
  - ▲ Children and adults should be alerted to the hazards of high surface temperatures and should stay away to avoid burns or clothing ignition.
  - ▲ Young children should be carefully supervised when they are in the area of the appliance.
  - ▲ Clothing or other clammable materials should not be hung from the appliance or placed on or near the appliance.
  - ▲ Any guard or other protective device removed for servicing the appliance must be replaced prior to operating the appliance.
  - ▲ Do NOT attempt to move or store this outdoor fireplace until all parts are cool.
  - ▲ Do NOT lean over this outdoor fireplace when lighting or when in use.
  - ▲ This outdoor fireplace should be thoroughly inspected and cleaned on a regular basis.
  - ▲ This outdoor fireplace should be thoroughly cleaned and inspected on a regular basis. Clean and inspect the hose before each use of the appliance. If there is evidence of abrasion, wear, cuts, or leaks, the hose must be replaced prior to the appliance being put into operation.
  - ▲ Use only the regulator and hose assembly provided. The replacement regulator and hose assembly shall be that specified by the manufacturer.
  - ▲ Use only Blue Rhino Global Sourcing, Inc factory authorized parts. The use of any part that is NOT factory authorized can be dangerous and will void your warranty.
  - ▲ Storage of this outdoor fireplace indoors is permissible only if the tank is disconnected, removed from the outdoor fireplace and properly stored outdoors.
  - ▲ Do not attempt to disconnect the gas regulator from the tank or any gas fitting while the outdoor fireplace is in use.
  - ▲ If the outdoor fireplace is not in use, the gas must be turned off at the supply tank.
  - ▲ The pressure regulator is set for 10.5 inches of water column (pressure).
  - ▲ The maximum inlet gas pressure for this outdoor fireplace is 11 inches of water column pressure.
  - ▲ Do NOT sit on the mantle when the unit is in operation.
  - ▲ Do not throw anything onto the fire when the unit is in operation.
  - ▲ Fire logs and lava rock are very hot, please keep the children or pets away at a safe distance.
  - ▲ The opening of the tank collar should face toward the door side for easy access.
  - ▲ Do NOT store any combustible materials in the base enclosure.



Contact 1.800.762.1142 for assistance. Do not return to place of purchase.

## Parts List

- 1** Cement Log (4)  
55-05-432, 55-05-433,  
55-05-434, 55-05-435
- 2** Lava Rock  
55-05-443
- 3** Lava Rock Grid  
55-05-444
- 4** Side Panel (6)  
58-05-028
- 5** Bowl Assembly  
55-05-430
- 6** Burner  
55-05-431
- 7** Igniter  
55-05-441
- 8** Control Knob  
55-05-436
- 9** Regulator/Hose Assembly  
55-05-452
- 10** Hearth  
58-05-025
- 11** Back Leg (2)  
55-05-694
- 12** Middle Support Leg (3)  
55-05-702
- 13** Tank Guard  
55-05-458
- 14** LP Gas Tank Retaining Chain  
55-05-447
- 15** LP Gas Tank Tray Peg  
55-05-449
- 16** Base Support Bar  
55-05-429
- 17** Left Front Leg  
55-05-700
- 18** Left Door  
58-05-026
- 19** Door Support Leg  
55-05-698
- 20** Right Door  
58-05-027
- 21** Right Front Leg  
55-05-704
- 22** Door Knob (2)  
55-05-697
- 23** Base  
55-05-428
- 24** LP Gas Tank Tray  
55-05-448
- 25** LP Gas Tank Shield  
55-05-458
- 26** Foot (4)  
55-05-692
- 27** Cover (not shown)  
55-05-693

## Exploded View

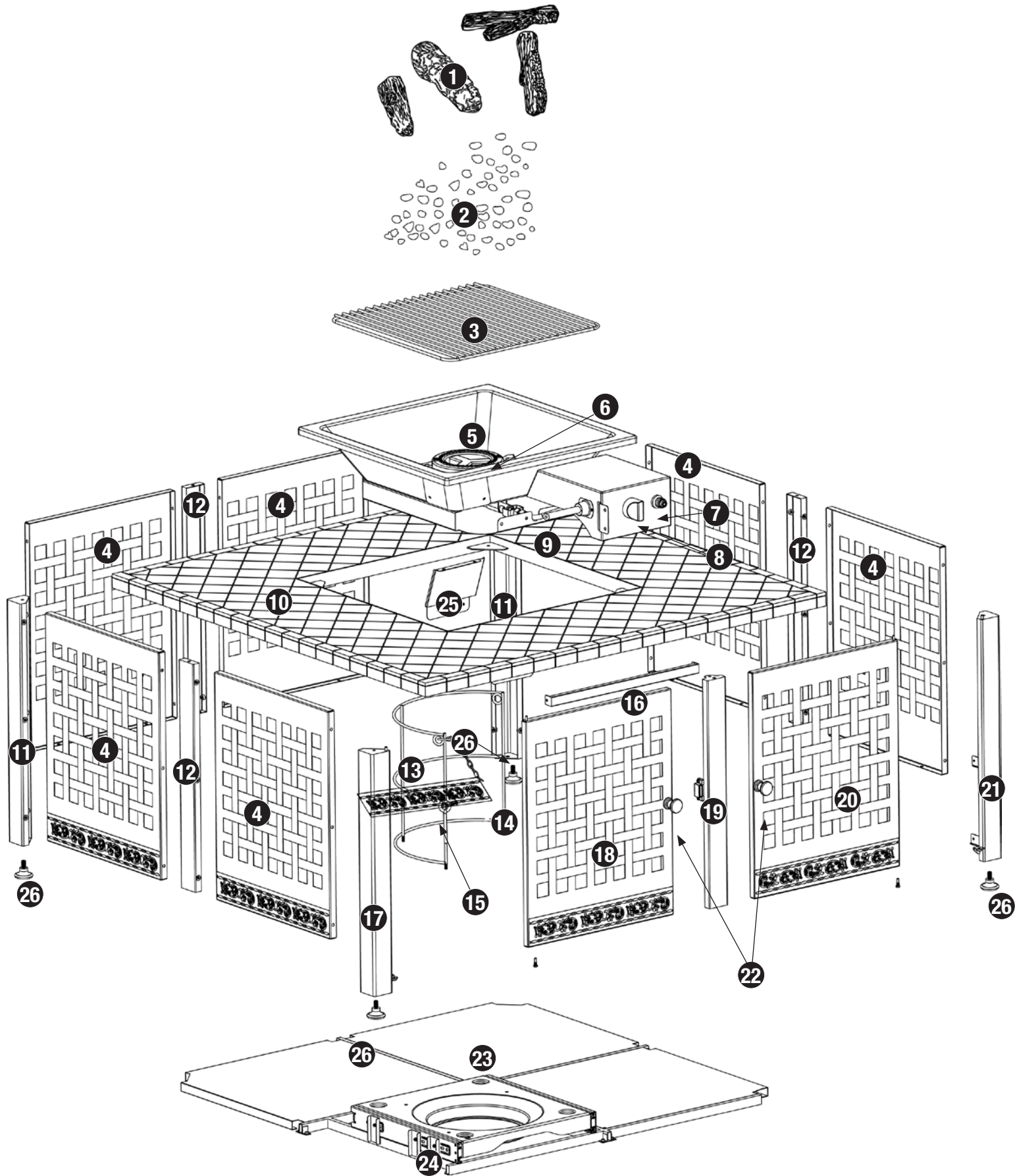

## Hardware

<b>A</b>	Screw	M5x10 Black Nickel Plated Truss Head	68 pcs
<b>B</b>	Screw	M5x10 Black Nickel Plated Hex	9 pcs
<b>C</b>	Screw	ø4x16 Black Nickel Plated Truss Head	2 pcs
<b>D</b>	Wing Nut	ø5 Black Nickel Plated	3 pcs
<b>E</b>	AA Battery	1.5 V AA Battery	1 pc

## Tools Required for Assembly (Included)

M5 Allen Wrench



## Tools Required for Assembly (Not Included)

#2 Phillips Head Screwdriver

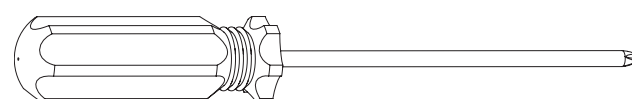

**Assembly Instructions**

**1 DO NOT RETURN PRODUCT TO STORE.**

For assistance call **1.800.762.1142** toll free. Please have your owner's manual and serial number available for reference.

For Easiest Assembly:

- To avoid losing any small components or hardware, assemble your product on a hard level surface that does not have cracks or openings.
- Clear an area large enough to layout all components and hardware.
- When applicable, tighten all hardware connections by hand first. Once the step is completed go back and fully tighten all hardware.
- Follow all steps in order to properly assemble your product.

To complete assembly you will need:

- (1) Leak Detection Solution (Instructions on how to make solution are included in step Operations Section)
- (1) Precision Filled LP Gas Grill Tank with Acme Type 1 external threaded valve connection (4-5 gallon size)

*Note:* You must follow all steps to properly assemble heater.

Typical assembly: approximately 1 (one) hour.

**2 Attach Bowl Assembly**

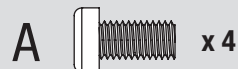
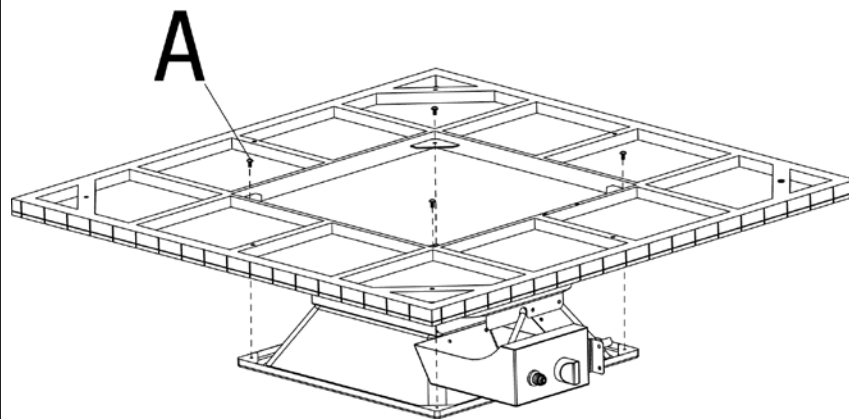

**3 Attach LP Gas Tank Shield**

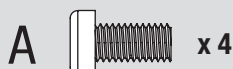
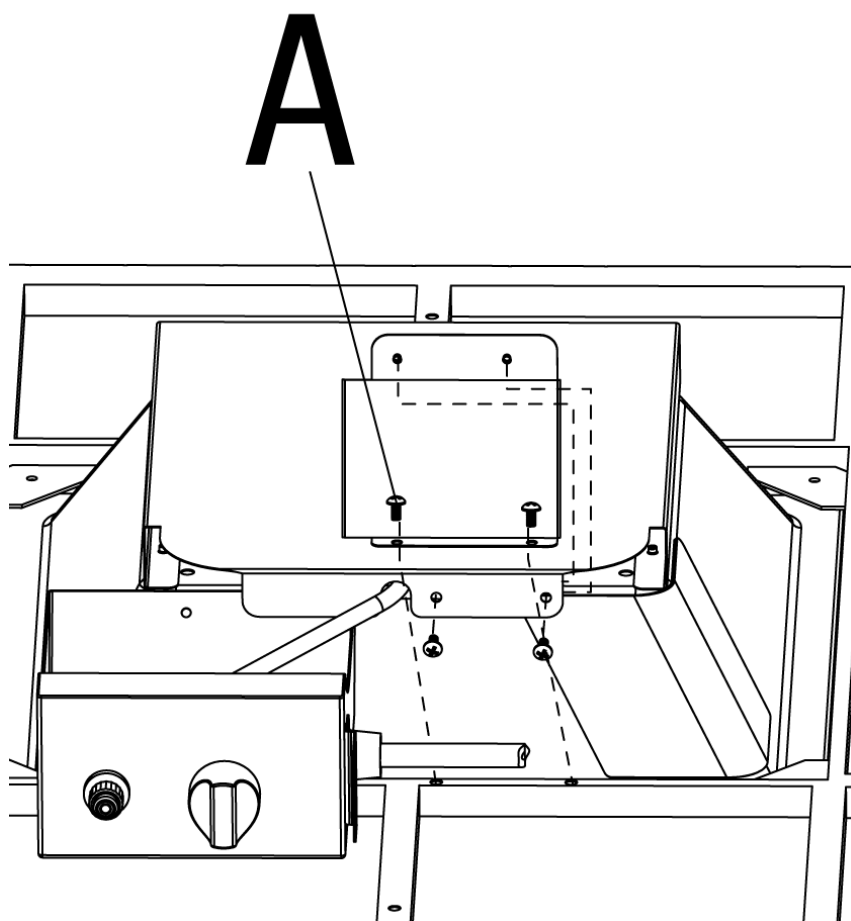

**4 Attach Side Panels, Back Legs and Middle Support Leg**

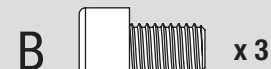
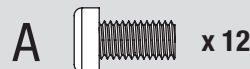
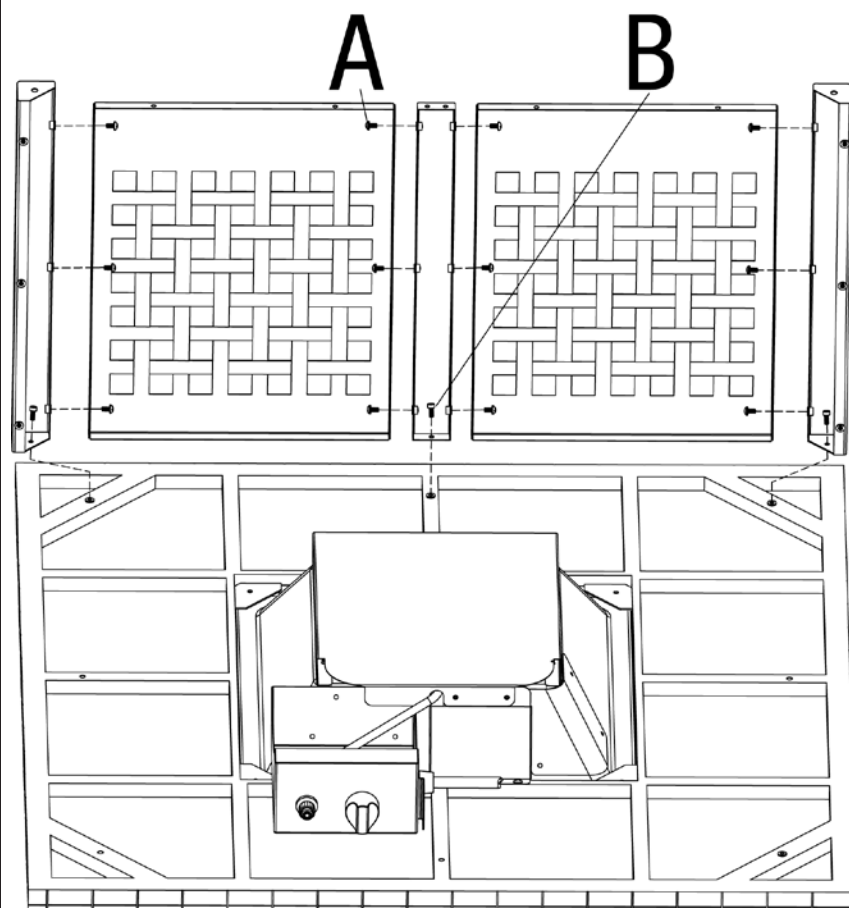

### 5 Attach Side Panels, Left Front Leg and Middle Support Leg

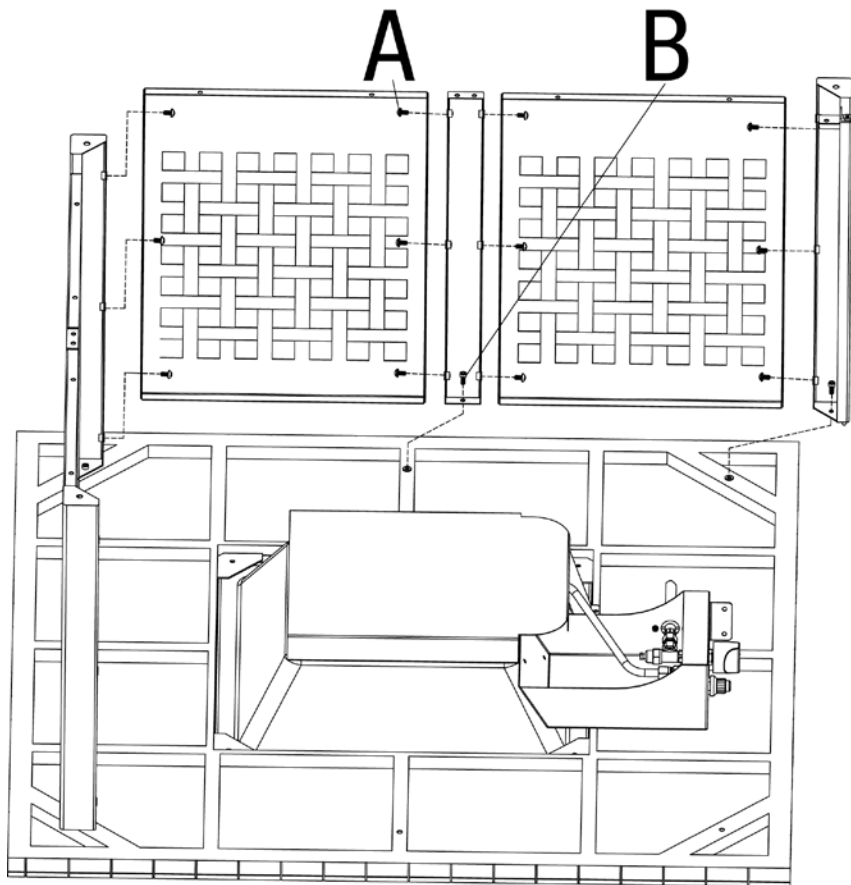

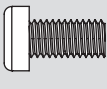
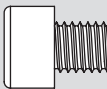
- A  x 12      B  x 2

### 6 Attach Side Panels, Right Front Leg and Middle Support Leg

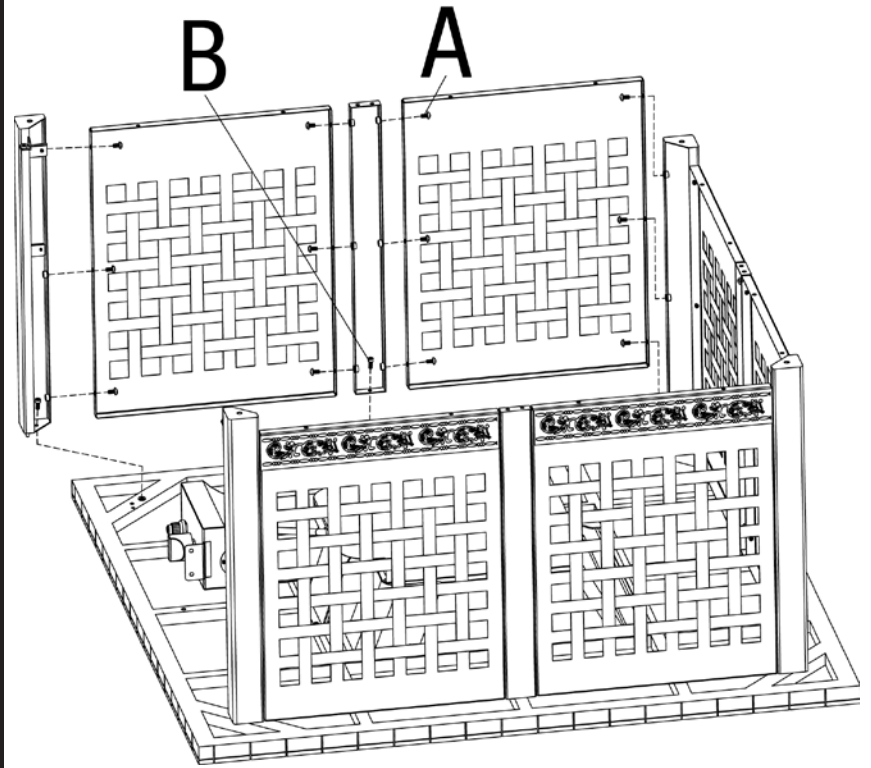

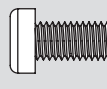
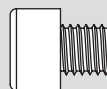
- A  x 12      B  x 2

### 7 Attach Base and Feet

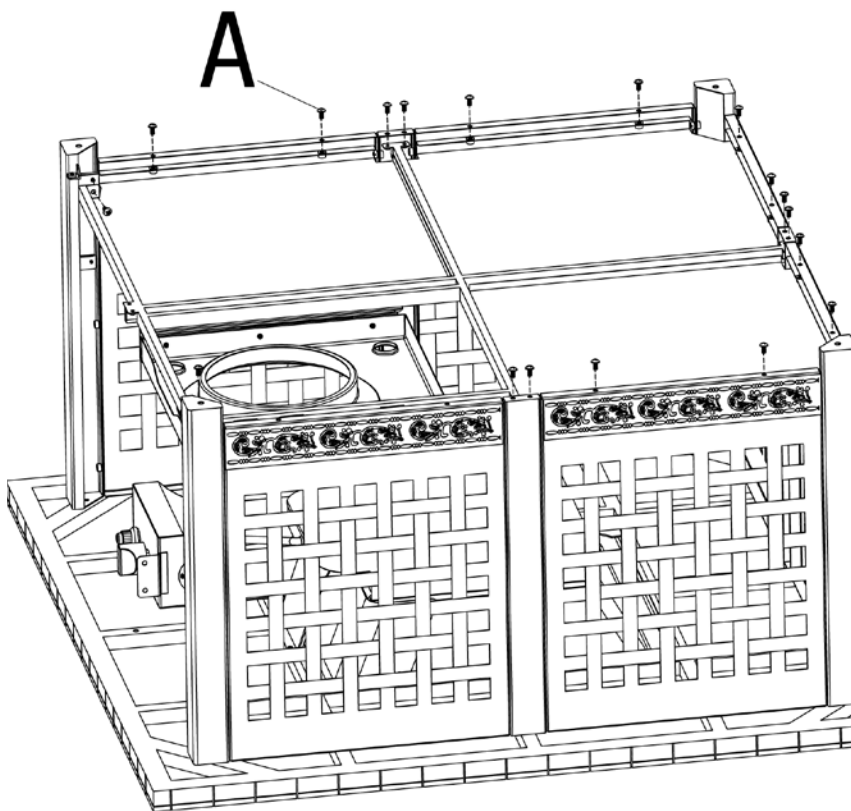

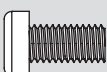
- A  x 18

### 8 Attach Door Support Leg

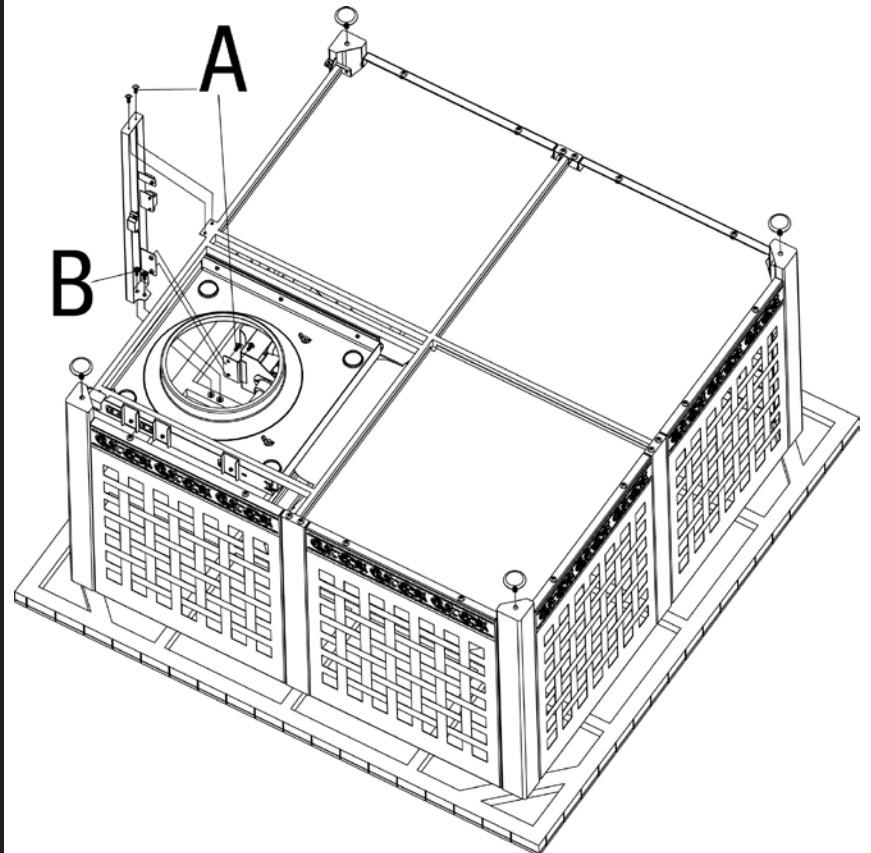

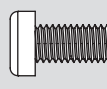
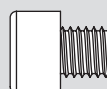
- A  x 4      B  x 2



Assembly Instructions (continued)

9

Attach Tank Guard

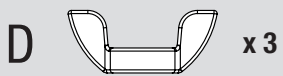
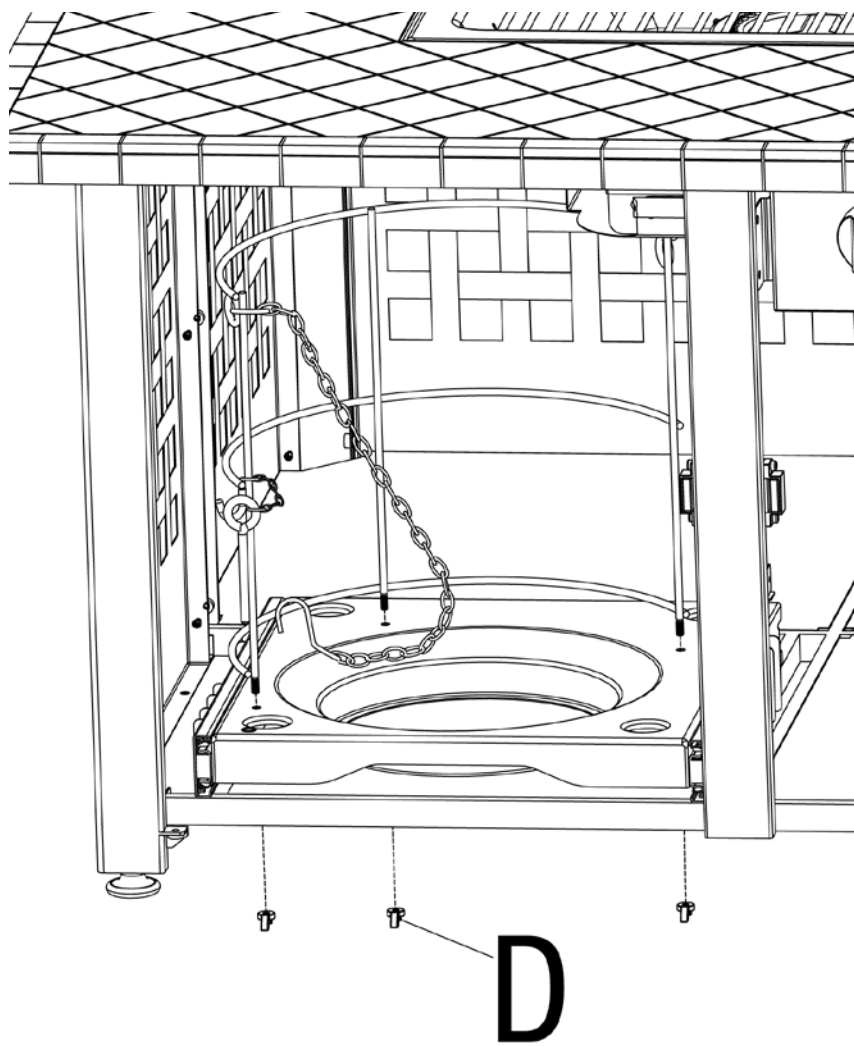

10

Attach Base Support Bar

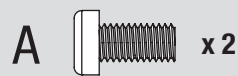
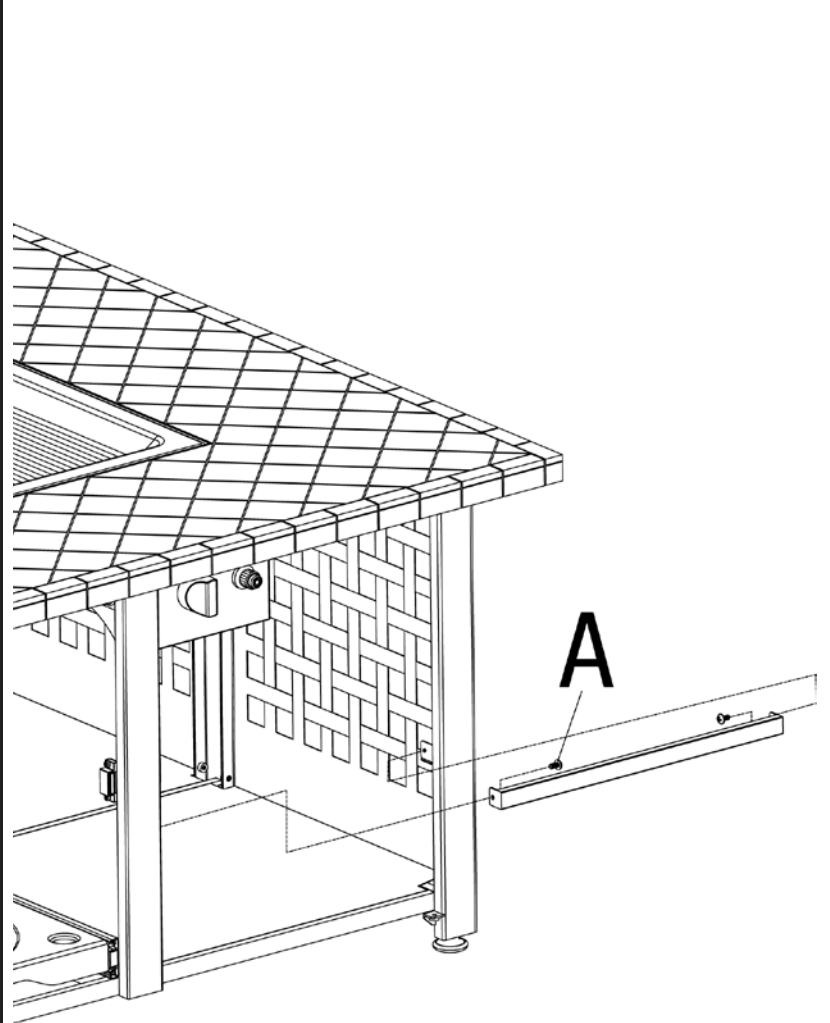

11

Attach Doors

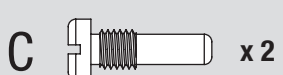
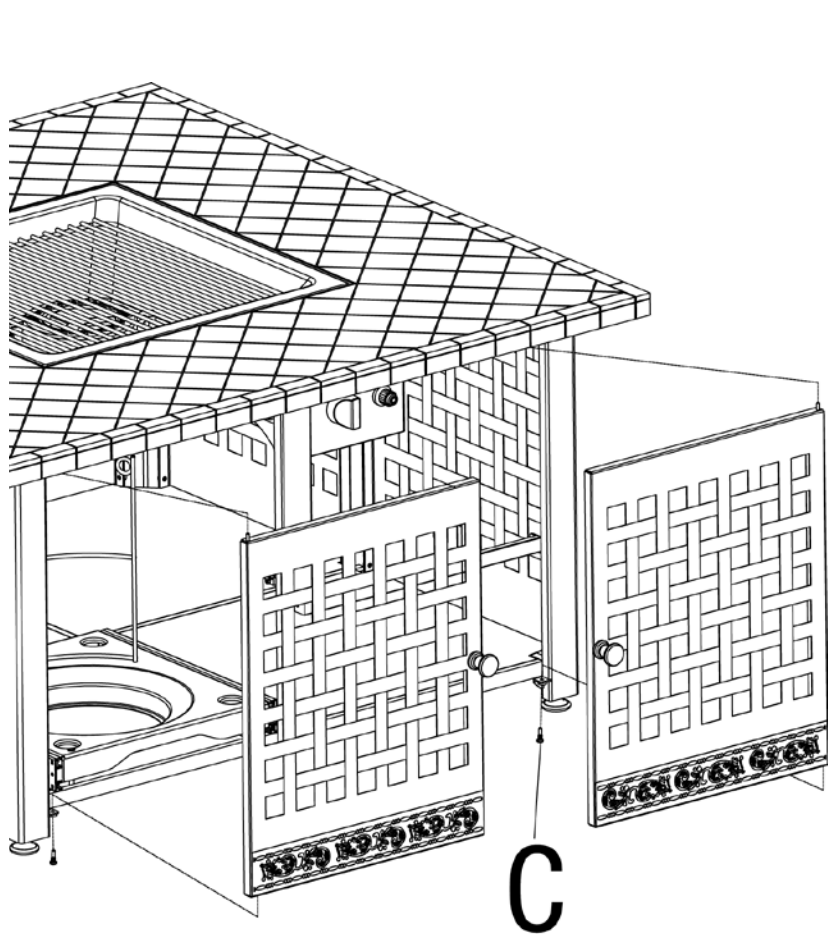

12

Place Wood Grid and Lava Rocks

Do NOT dump lava rocks out of package. Carefully place lava rocks by hand so dust does not clog burner.

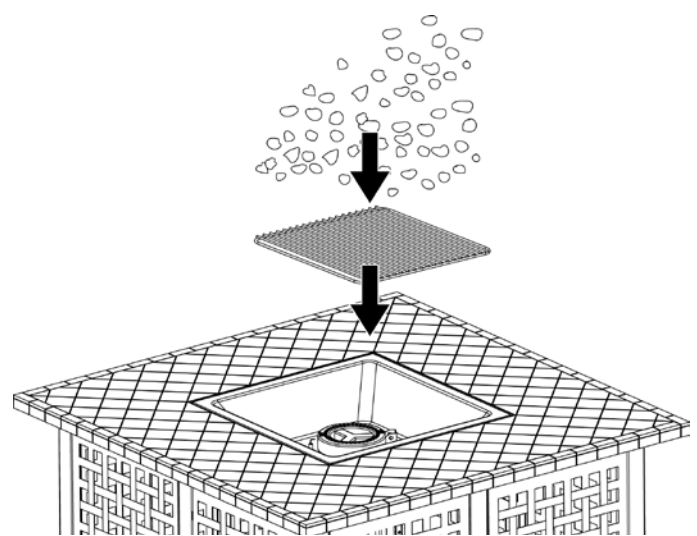

Place Cement Logs

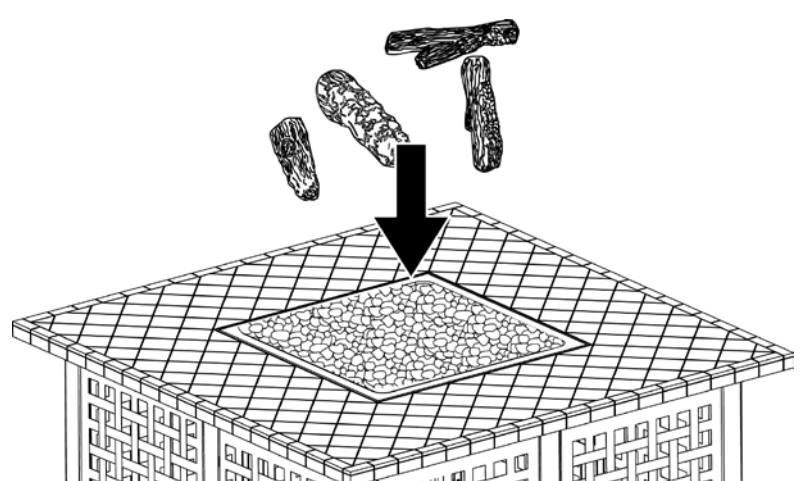

# 13

## Insert Battery

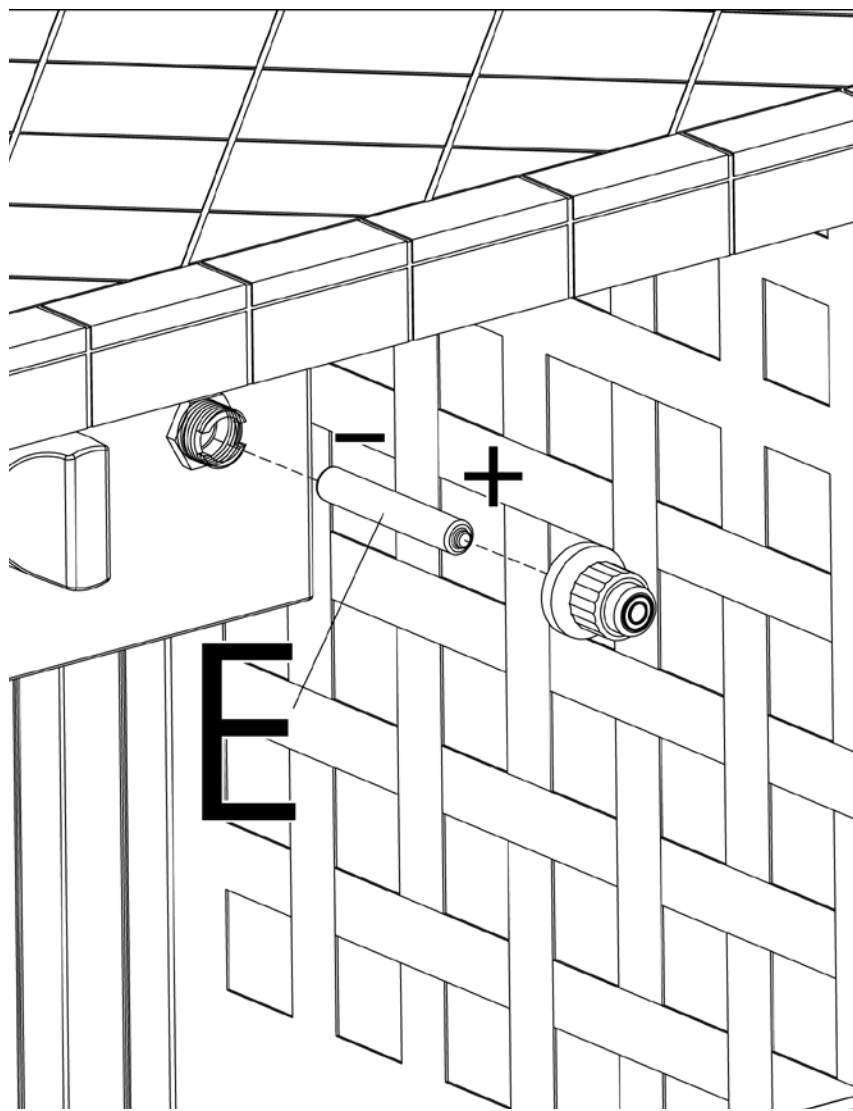

E  x 1

## Installing LP Gas Tank

To operate you will need (1) precision-filled standard grill LP gas tank (20#) with external valve threads.

*Note:* An empty standard grill LP gas tank weighs approximately 18 lbs. A precision-filled standard grill LP gas tank should weigh no more than 38 lbs.



**Need a tank of gas?** Try tank exchange service. It's easy, fast, safe, and available at tens of thousands of conveniently located retail outlets nationwide. You can purchase a new full tank or exchange your empty for a precision filled one.

## Insert LP Gas Tank

**⚠ WARNING:** Make sure LP gas tank valve is closed. Close by turning valve clockwise.

Place precision filled LP gas tank upright into hole in outdoor fireplace body so it is arranged for vapor withdrawal.

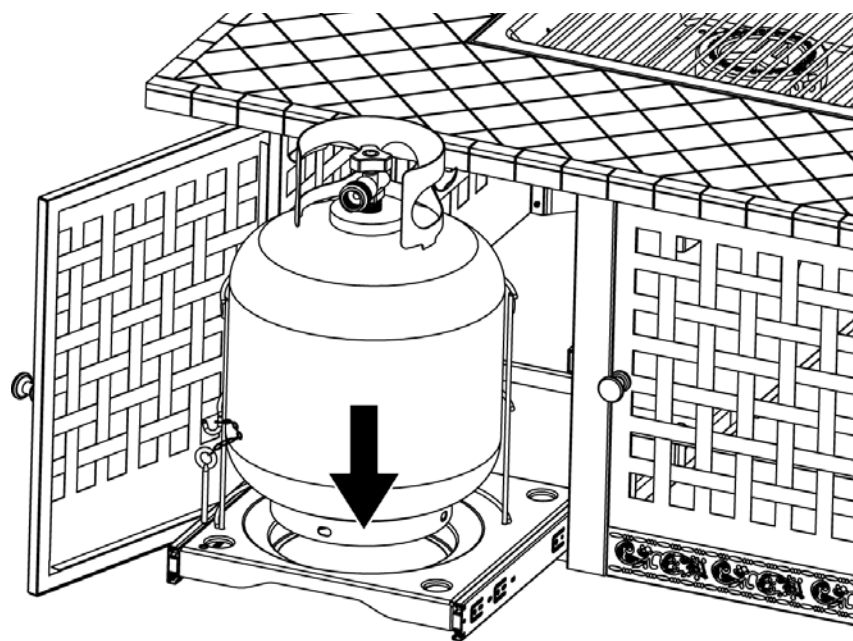

## Secure LP Gas Tank

Secure tank by sliding tank retainer chain around the LP gas tank and insert peg into LP gas tank tray.

*Note:* Peg must be inserted into LP gas tank when tank is in LP gas tank tray.

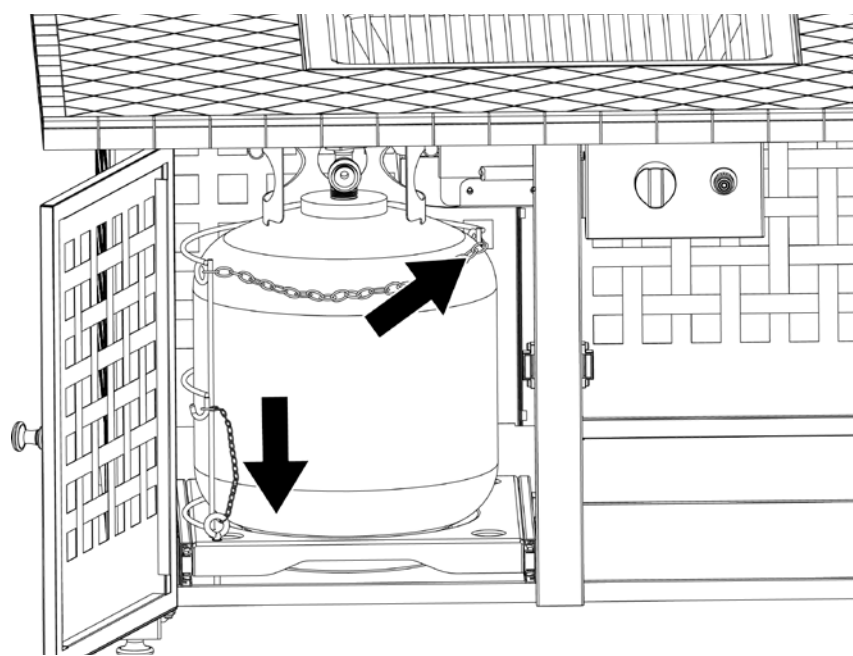

## Connect LP Gas Tank

Before connecting, be sure that there is no debris caught in the head of the LP gas tank, head of the regulator valve or in the head of the burner and burner ports.

Connect gas line to tank by turning knob clockwise until it stops.

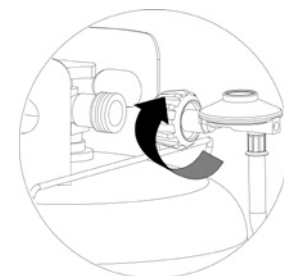

## Disconnect LP Gas Tank

Before disconnecting make sure the LP gas tank valve is OFF.

Disconnect gas line to tank by turning knob counterclockwise until it is loose.

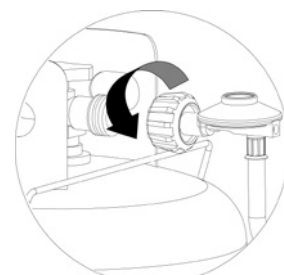



## Operating Instructions

### Checking for Leaks

**▲ WARNING:** Before using this outdoor fireplace, make sure you have read, understand and are following all information provided in the Dangers and Warnings presented on page 2. Failure to follow those instructions can cause death, serious injury or property damage.

#### Burner Connections

Make sure the regulator valve and hose connections are securely fastened to the burner and the tank.

If your unit was assembled for you, visually check the connection between the burner pipe and orifice. Make sure the burner pipe fits over the orifice.

**▲ WARNING:** Failure to inspect this connection or follow these instructions could cause a fire or an explosion which can cause death, serious bodily injury, or damage to property.

Please refer to diagram for proper installation.

If the burner pipe does not rest flush to the orifice, please contact 1.800.762.1142 for assistance.

#### Tank/Gas Line Connection

Make 2-3 oz. of leak solution by mixing one part liquid dishwashing soap with three parts water.

Make sure control knob is OFF.

Turn LP gas tank ON at valve.

Spoon leak check solution at all "x" locations

If any bubbles appear turn LP gas tank OFF, reconnect and re-test. If you continue to see bubbles after several attempts, disconnect LP gas source and contact 1.800.762.1142 for assistance.

If no bubbles appear after one minute turn tank OFF, wipe away solution and proceed.

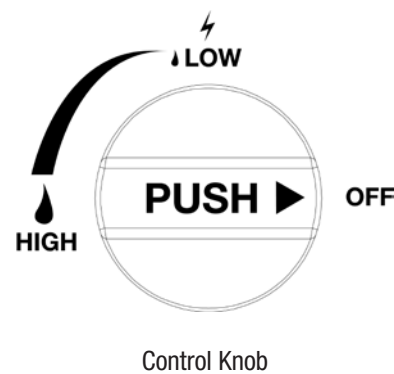
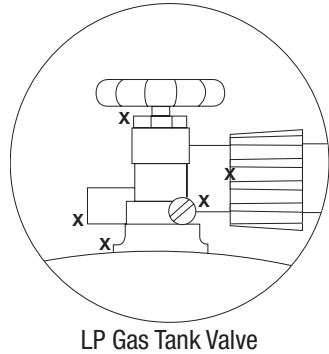
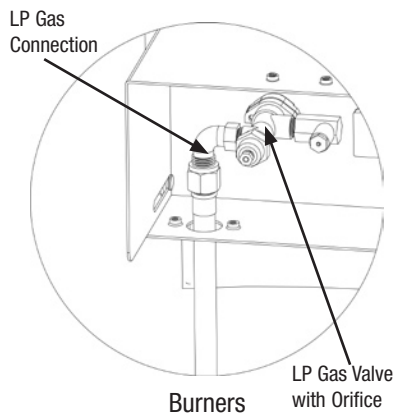

### Lighting

1. Make sure there are no obstructions of airflow to the gas unit. Spiders and insects can nest within and clog the burner / venturi tube at the orifice. A clogged burner tube can lead to a fire beneath the appliance.

2. Control knob must be in the "OFF" position.

3. Turn on gas at LP gas tank.

4. Push and turn control knob counterclockwise to "LOW".

5. Press the electronic igniter and hold for 5 seconds to light burner.

6. Release control knob after 45 seconds.

7. If ignition does not occur in 45 seconds, turn burner control knob "OFF", wait 5 minutes, fan with newspaper or magazine, and repeat lighting procedure.

8. If igniter does not light burner, use a long match or long butane lighter.

**▲ CAUTION:** Before Lighting - Using a shovel to carefully move the lava rocks to access the burner.

a. Wearing Heat resistant gloves, position the lit long match or lit long butane lighter near the side of the burner.

b. Turn control knob counterclockwise to "LOW".

c. Remove long match/long butane lighter.

**▲ CAUTION:** After Lighting - Using a shovel and heat resistant gloves, carefully move the lava rocks back to their proper position, being careful to avoid the flame.

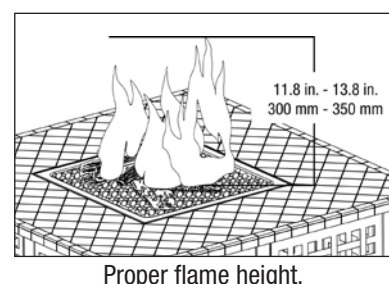
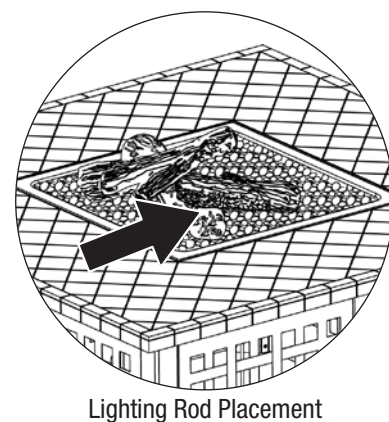

9. After lighting, observe the burner flame, make sure all burner ports are lit and flame height matches illustration.

10. Adjust flame to desired flame with the control knob.

**▲ CAUTION:** If burner flame goes out during operation, immediately turn the gas "OFF" and let the gas clear and fan with newspaper or magazine for about 5 minutes before re-lighting.

### Turning Off

1. Turn gas off at LP tank.

2. Turn all control knobs clockwise to the OFF position.

## Cleaning and Care

### Inspecting

This outdoor fireplace should be inspected on a regular basis to ensure product safety and longer product life.

**▲ WARNING:** Do NOT attempt to inspect this outdoor fireplace until the fire is COMPLETELY out.

1. Check burner and log set to make sure they are secure.

2. Check venturi to make sure it is clear and free of spider nests.

3. Check all gas connections for leaks.

4. Check ignition system to insure proper sparking.

5. Check components for any signs of damage or rust.

6. If damage to any component is detected, do NOT operate until repairs are executed.

### Cleaning

This outdoor fireplace should be cleaned on a regular basis to promote safer experiences and longer product life.

*Note:* After repeated use, a slight discoloration of the finishes may occur.

**▲ WARNING:** Do NOT attempt to clean this outdoor fireplace unless the fire is COMPLETELY out and unit is cool to the touch.

**▲ WARNING:** Do NOT use oven cleaner or abrasive cleaners as they will damage this product.

1. Wipe exterior surfaces with a mild dishwashing detergent or baking soda.

2. Rinse clean with water.

### Storage

**▲ WARNING:** Do NOT move or store this outdoor fireplace unless the fire is COMPLETELY out and is cool to the touch.

1. Turn gas OFF at tank connection. Remove tank and store in a cool dry location outdoors away from children.

2. Carefully disassemble log set and store components flat in the fire bowl area to protect them from breakage.

3. Cover outdoor fireplace with a durable vinyl cover designed to fit this unit.

4. Store in a cool and dry location away from children and pets.



## Troubleshooting

Problem	Possible Cause	Prevention/Cure
Burner will not light using igniter	Electrode and burners are wet.	Wipe dry with cloth.
	Electrode cracked or broken - sparks at crack.	Replace electrode.
	Wire loose or disconnected.	Reconnect wire or replace electrode/wire assembly
	Wire is shorting (sparking) between igniter and electrode.	Replace igniter wire/electrode assembly
	Bad igniter.	Replace igniter
Burner will not light with match	No gas flow.	Check if LP gas tank is empty. If LP gas tank is not empty, refer to "Sudden drop in gas flow (reduced flame height)". If empty, replace or refill.
	Coupling nut and regulator not fully connected.	Turning the coupling nut about one-half to three quarters additional turn until solid stop. Tighten by hand only-do not use tools.
	Obstruction of gas flow.	Clear burner tubes. Check for bent or kinked hose.
	Disengagement of burner to valve.	Reengage burner and valve.
	Spider webs or insect nest in venturi.	Clean venturi.
	Burner ports clogged or blocked.	Clean burner ports.
Sudden drop in gas flow or reduced flame height	Out of gas.	Check for gas in the LP gas tank
	Excess flow safety device may have been activated.	Turn control knob to "OFF", wait 30 seconds and light outdoor fireplace. If flames are still too low reset the excessive flow safety device by turning off knobs and LP gas tank valve. Disconnect regulator. Turn burner control knobs to "HIGH". Wait 1 minute. Turn burner control knob off. Reconnect regulator and leak check connections. Turn LP gas tank valve on slowly, wait 30 seconds and then light outdoor fireplace.
Irregular flame pattern	Burner ports are clogged or blocked.	Clean burner ports.
Flame blow out	High or gusting winds	Increase flame height to "HIGH" setting
	Low on LP Gas	Replace or refill LP gas tank
	Excess flow valve tripped	Refer to "Sudden drop in gas flow"
Flame seems to lose heat when burning in cold weather - temperature below 50°F	Ice has built up on the outside of the LP gas tank because the vaporization process is too slow.	Turn "OFF" the control knob and the LP gas tank. Replace with a spare LP gas tank and resume burning. Store a spare LP gas tank in a well ventilated area away from children.
<b>If problems can not be corrected by using these methods, please contact 1.800.762.1142 for assistance.</b>		

## Product Registration

For faster warranty service, please register your product immediately at [www.bluerhino.com](http://www.bluerhino.com) or call 1.800.762.1142.

## Limited Warranty

Blue Rhino Global Sourcing, Inc ("Vendor") warrants to the original retail purchaser of this product, and to no other person, that if this product is assembled and operated in accordance with the printed instructions accompanying it, then for a period of one (1) year from the date of purchase, all parts in such product shall be free from defects in material and workmanship. Vendor may require reasonable proof of your date of purchase. Therefore, you should retain your sales slip or invoice. This Limited Warranty shall be limited to the repair or replacement of parts, which prove defective under normal use and service and which Vendor shall determine in its reasonable discretion upon examination to be defective. Before returning any parts, you should contact Vendor's Customer Service Department using the contact information listed below. If Vendor confirms, after examination, a defect covered by this Limited Warranty in any returned part, and if Vendor approves the claim, Vendor will replace such defective part without charge. If you return defective parts, transportation charges must be prepaid by you. Vendor will return replacement parts to the original retail purchaser, freight or postage prepaid.

This Limited Warranty does not cover any failures or operating difficulties due to accident, abuse, misuse, alteration, misapplication, improper installation or improper maintenance or service by you or any third party, or failure to perform normal and routine maintenance on the product as set out in this owner's manual. In addition, the Limited Warranty does not cover damage to the finish, such as scratches, dents, discoloration, rust or other weather damage, after purchase.

This Limited Warranty is in lieu of all other express warranties. Vendor disclaims all warranties for products that are purchased from sellers other than authorized retailers or distributors, including the warranty of merchantability or the warranty of fitness for a particular purpose. VENDOR ALSO DISCLAIMS AND ANY ALL IMPLIED WARRANTIES, INCLUDING WITHOUT LIMITATION THE IMPLIED WARRANTIES OF MERCHANTABILITY AND FITNESS FOR A PARTICULAR PURPOSE. VENDOR SHALL NO LIABILITY TO PURCHASER OR ANY THIRD PARTY FOR ANY SPECIAL, INDIRECT, PUNITIVE, INCIDENTAL, OR CONSEQUENTIAL DAMAGES. Vendor further disclaims any implied or express warranty of, and assumes no responsibility for, defects in workmanship caused by third parties.

This Limited Warranty gives the purchaser specific legal rights; a purchaser may have other rights depending upon where he or she lives. Some jurisdictions do not allow the exclusion or limitation of special, incidental or consequential damages, or limitations on how long a warranty lasts, so the above exclusion and limitations may not apply to everyone.

Vendor does not authorize any person or company to assume for it any other obligation or liability in connection with the sale, installation, use, removal, return, or replacement of its equipment, and no such representations are binding on Vendor.

Blue Rhino Global Sourcing, Inc  
Winston-Salem, North Carolina USA  
(800) 762-1142







